

Applications: Provides guidance, support, movement or positioning for screens, panels, boards, and components used in medical apparatus, machinery, and manufacturing equipment.

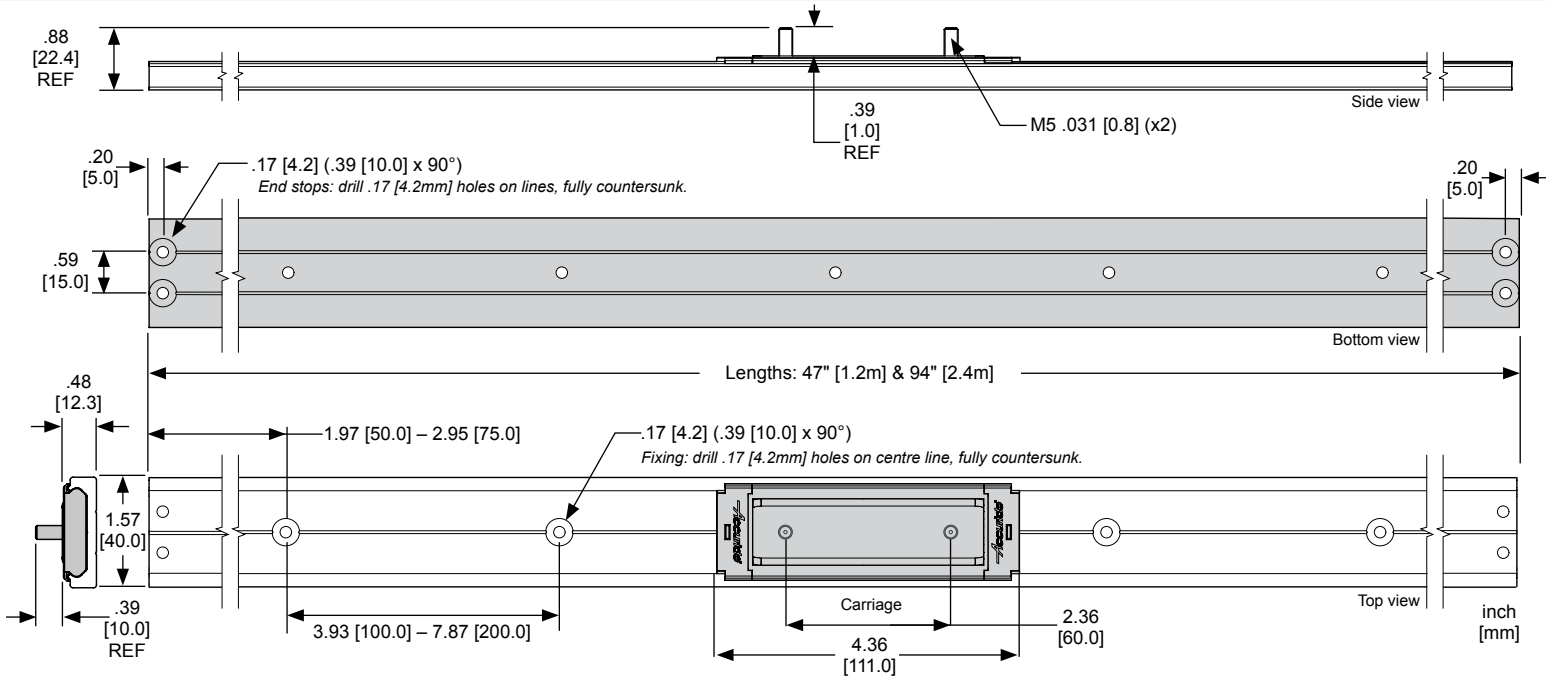

Track material Aluminum 6000 series
Track length 47" [1.2m] & 94" [2.4m]
Ball carriages Stainless steel and nylon
Ball bearings Stainless steel or polymer
Load rating Up to 265 lb. [120 kg]

Mounting Side, flat, or vertical*
Hardware M4 countersunk screw
 4mm countersunk wood screw
 (not included)



* Vertical mounting should be used only for non-load bearing applications.

Load Rating

The load bearing capacity is based on the type and number of carriages. Due to the extensive variety of applications and possible orientations, we recommend that customers test this product to their specific requirements. This product is not recommended for high-torque applications.

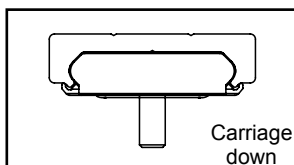
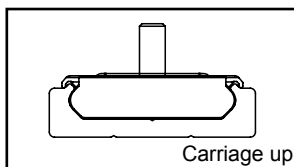
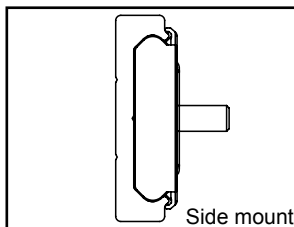

Side Mount			
SS0115-CASSRC Stainless Steel Ball Carriage	Load Rating	CB0115-CASSRC Polymer Ball Carriage	Load Rating
x1	110 lbs.	x1	65 lbs.
x2	200 lbs.	x2	120 lbs.
x3	265 lbs.	x3	160 lbs.
Flat Mount (carriage up)			
SS0115-CASSRC Stainless Steel Ball Carriage	Load Rating	CB0115-CASSRC Polymer Ball Carriage	Load Rating
x1	65 lbs.	x1	40 lbs.
x2	120 lbs.	x2	70 lbs.
x3	155 lbs.	x3	90 lbs.
Flat Mount (carriage down)			
SS0115-CASSRC Stainless Steel Ball Carriage	Load Rating	CB0115-CASSRC Polymer Ball Carriage	Load Rating
x1	90 lbs.	x1	50 lbs.
x2	155 lbs.	x2	90 lbs.
x3	200 lbs.	x3	120 lbs.

Note: Weight should be evenly distributed across the carriage(s).

Installation Instructions

Preparing the Track

1. Select the appropriate length of aluminum track.
2. Calculate the length of track required, keeping in mind the following measurements: each end stop is .39" [10 mm] wide and each carriage 4.37" [111mm] long.
3. Cut track to the determined length. Multiple lengths of track may be butted together for a longer span. When joining multiple lengths of track, pinning the track ends together provides increased stability.
4. Using the centerline on the front face of the track for guidance, measure along the length of the track and drill fixing holes as required. Each hole should be .17" [4.2mm] in diameter, fully countersunk. Holes should be placed 4–8" [100–200mm] apart and between 2–3" [50–75mm] from each end of the track. (Figure 1)
5. Using the two guidelines on the back of the track, measure .20" [5mm] in from each end of the track and drill holes .17" [4.2mm] in diameter, fully countersunk. Two holes per end, four holes total. (Figure 2)
6. If the track is to be permanently joined using the drill jig, place the jig within the end(s) to be joined, clamp it to the track surface and manually drill through the jig holes, into the end of the track using a 3mm drill bit. The depth of this hole is dependent on the size of pin that will be used. Note: Pins are not supplied. (Figure 3)
7. Clean the track of any particles and proceed to the assembly stage.
8. Fix one end stop to one end of the track using two screws. Leave the other end of the track open. (Figure 4)

Installing the Carriage

9. Align the outer plastic sheath of the carriage to the aluminum track and butt the end of the plastic sheath against the end of track. (Figure 5)
 10. Slide the carriage from the plastic sheath into the aluminum track. (Figure 6)
- Important Note:** Ensure the plastic sheath is fully pressed against the aluminum track before sliding the carriage through; otherwise the unit will fall out and drop ball bearings. Use a flat and even surface for this action to avoid misalignment.
11. Repeat until all carriages are installed within the confines of the track.
 12. Install the other end stop using two screws. Mount slide as desired.

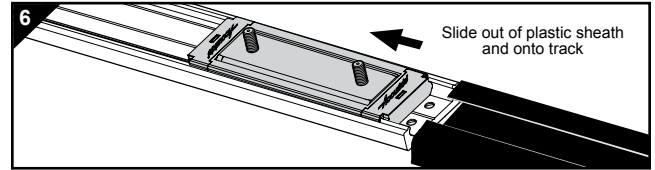
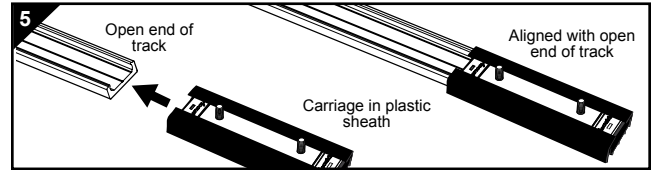
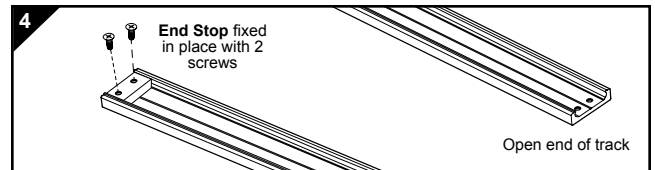
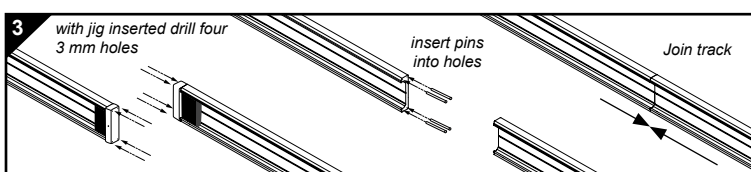
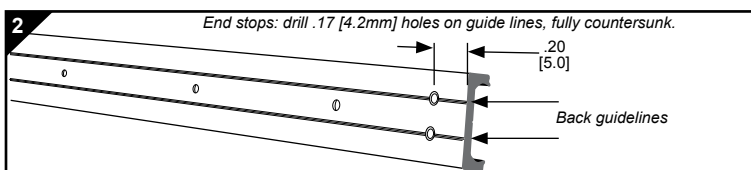
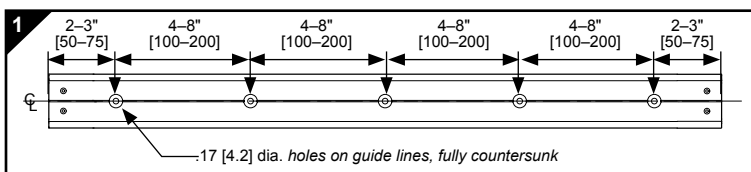

Packaging & Ordering

Tracks and carriages are packaged and sold singly. Fasteners are not included with track. For each complete span of track, order two End Stop Kits (AL0115-STOPRC).

Components

AL0115-0120RC	47" [1.2m] Aluminum track (x1)
AL0115-0240RC	94" [1.4m] Aluminum track (x1)
SS0115-CASSRC	Carriage – Stainless Steel Balls (x1)
CB0115-CASSRC	Carriage – Polymer Balls (x1)
AL0115-STOPRC	Aluminum End Stop (1 stop + 2 screws)

Order example

Complete your slide order for model 115RC by specifying the following:

	Qty	P/N	Length
Total Tracks	2 ea.	AL0115	0120RC
Total Ball Carriages	2 ea.	SS0115-CASSRC	
End Stop Kits	2	AL0115-STOPRC	

Optional accessory

Drilling Jig	DZ0115-DJIGRC
	Made to order – Locates holes to pin multiple lengths of track together.

Accuride

ACCURIDE INTERNATIONAL INC.

12311 Shoemaker Avenue
Santa Fe Springs, CA 90670

TEL (562) 903-0200

FAX (562) 903-0208

www accuride.com

Manufacturing, Engineering, and Sales

United States • Germany • Japan • Mexico • United Kingdom • China

Copyright © 2012 Accuride International Inc. 3700-9545(1246)-MK973-N-0412

For the most current technical information visit www accuride.com

Note: Specifications, materials, prices, terms and delivery are subject to change without notice.